

Name: _____

Date: _____

Perimeter: Rectangles, Triangles, and L-Shapes

Determine the perimeter of the following.

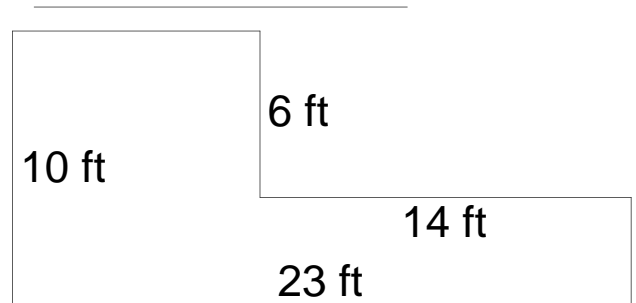
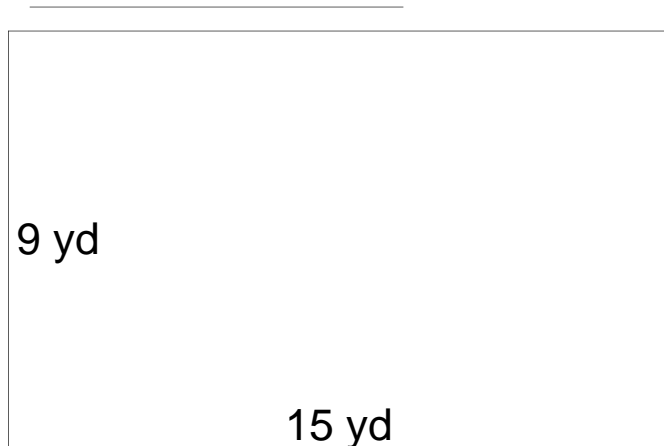
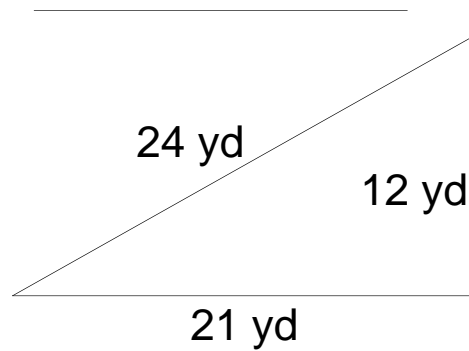
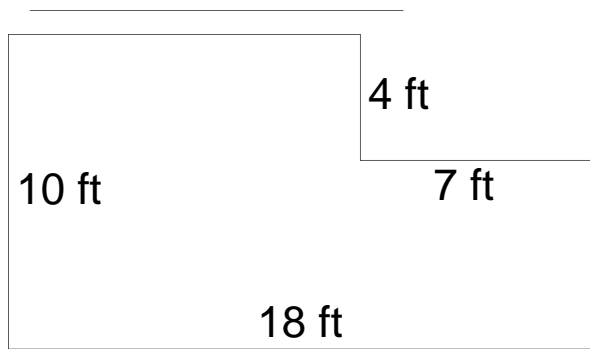
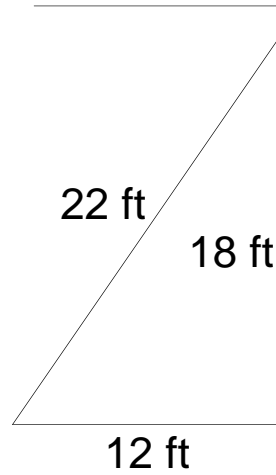
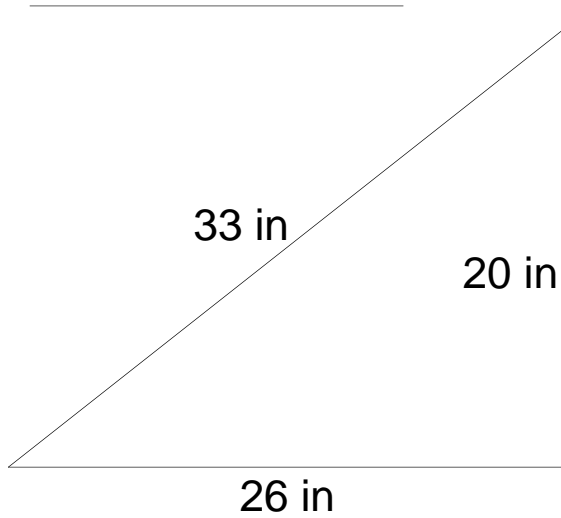

Name: _____

Date: _____



Perimeter: Rectangles, Triangles, and L-Shapes

Determine the perimeter of the following.

P=79in

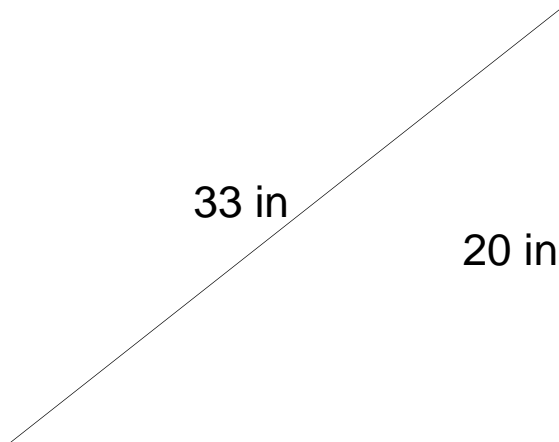

P=52ft

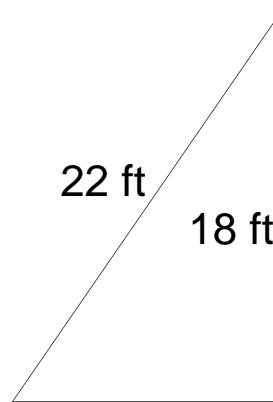

P=56ft 26 in

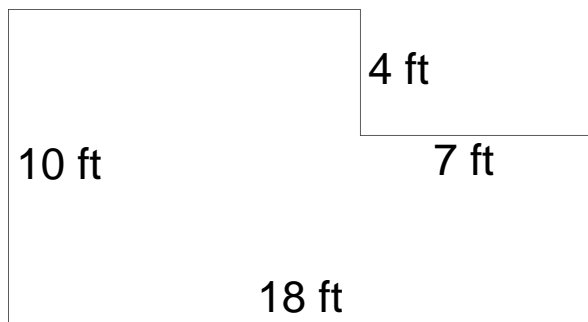

P=57yd

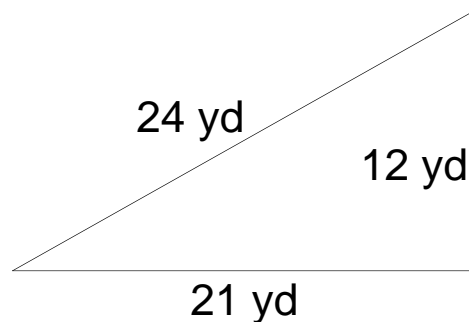

P=48yd

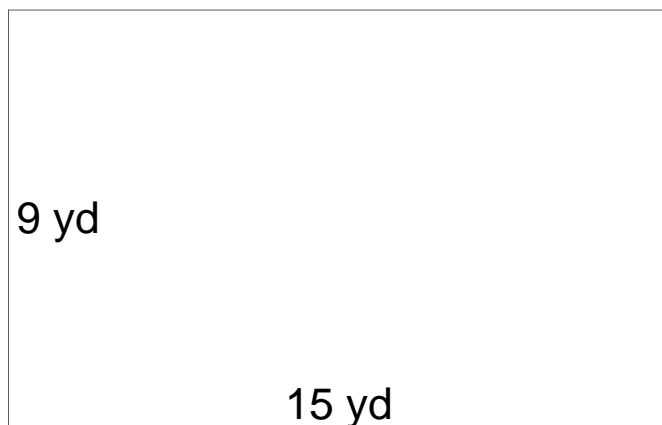

P=66ft

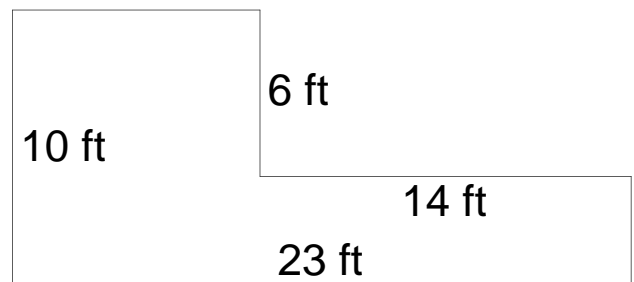

Name: _____

Date: _____

Perimeter: Rectangles, Triangles, and L-Shapes

Determine the perimeter of the following.

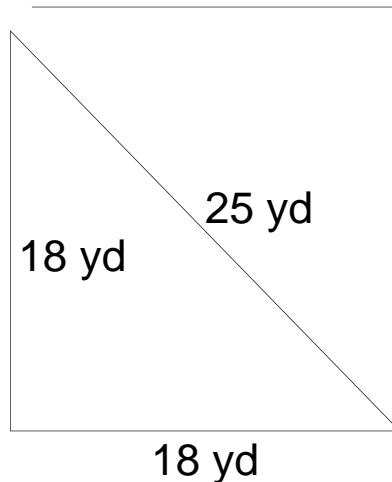
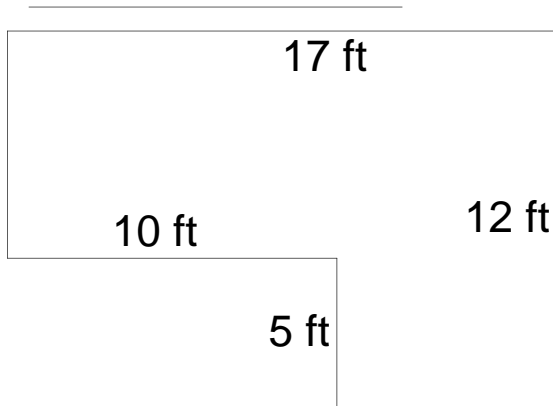
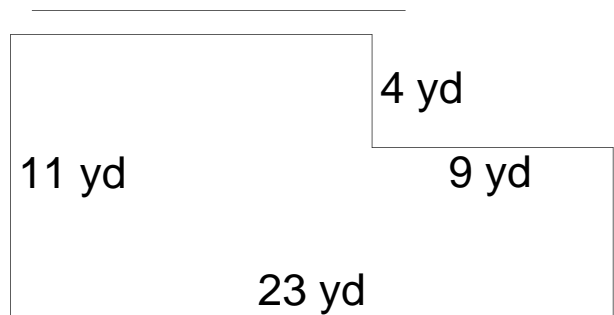
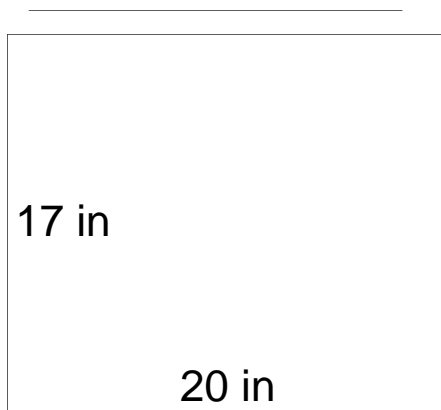
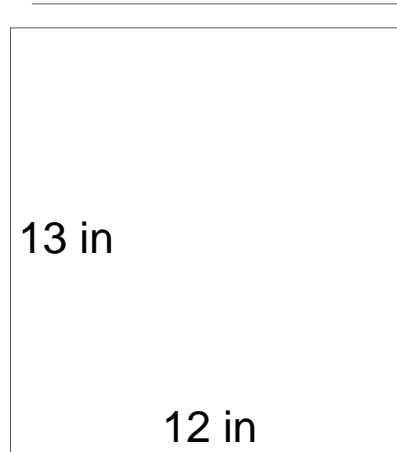
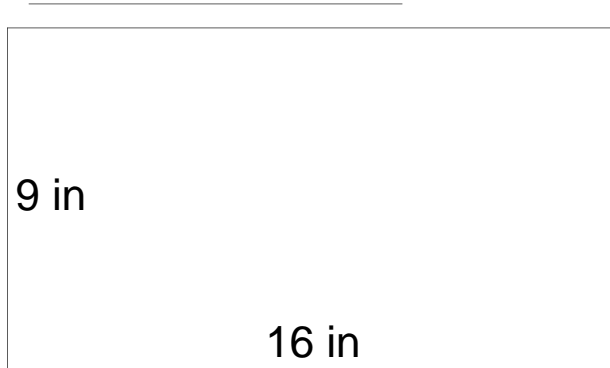

Name: _____

Date: _____



Perimeter: Rectangles, Triangles, and L-Shapes

Determine the perimeter of the following.

P=50in

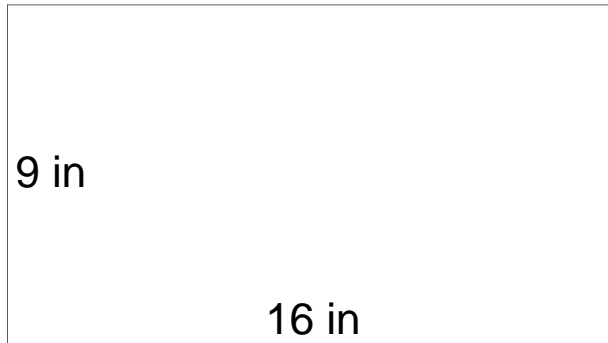

P=50in

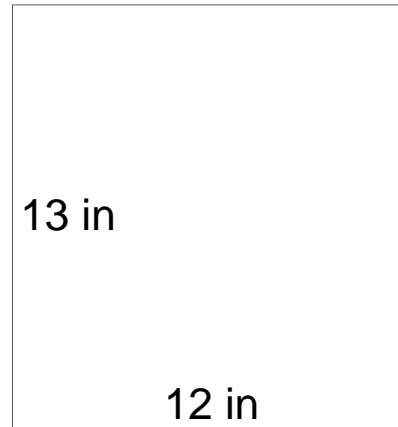

P=74in



P=68yd



P=58ft

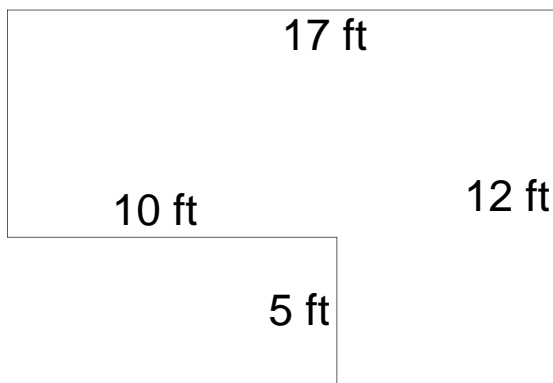

P=61yd

