

Name: _____

Date: _____

Perimeter: Rectangles and Triangles

Determine the perimeter of the following.

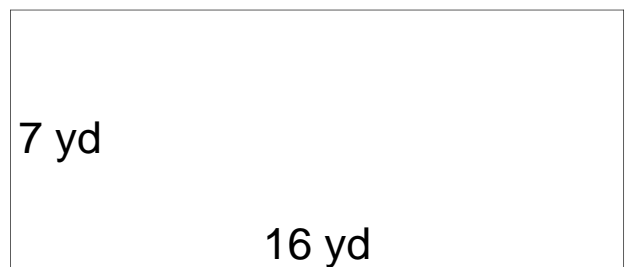
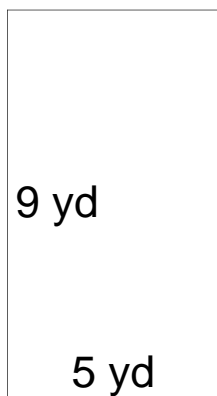
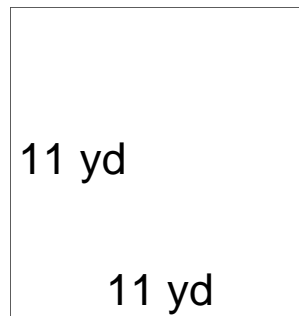
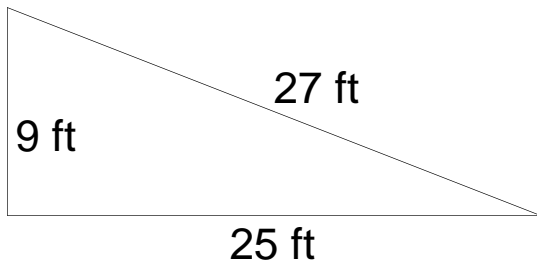
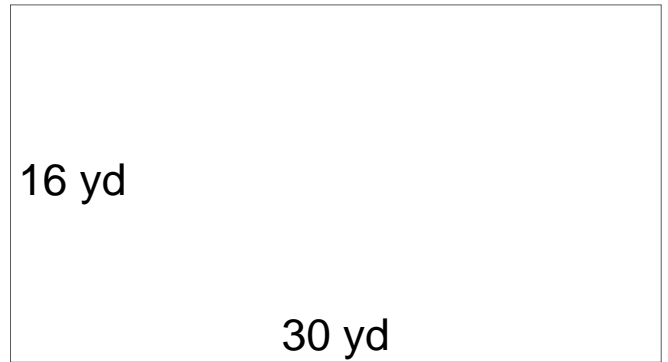
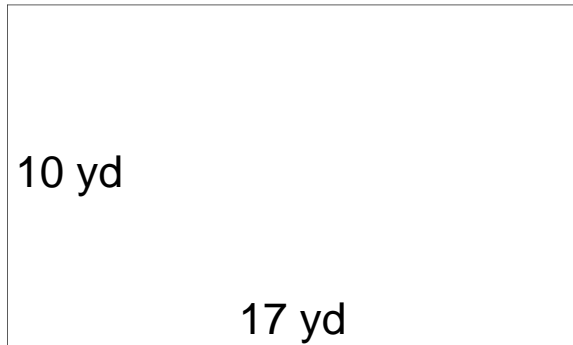

Name: _____

Date: _____



Perimeter: Rectangles and Triangles

Determine the perimeter of the following.

P=54yd

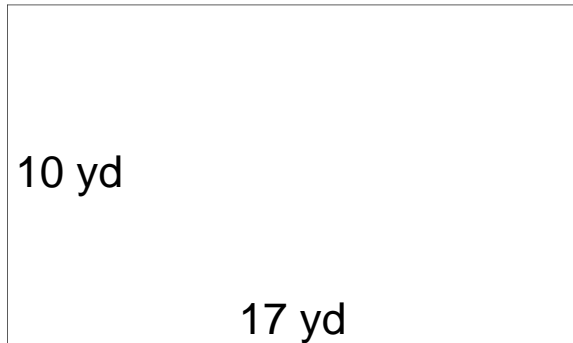

P=92yd

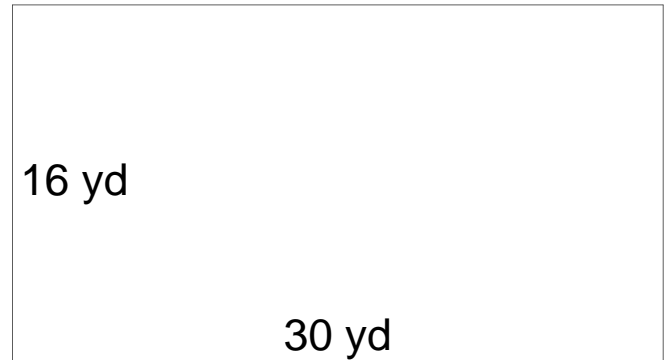

P=61ft

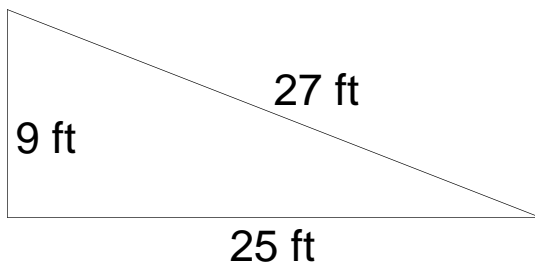

P=44yd

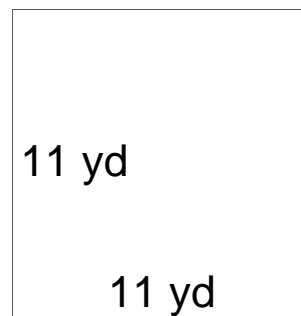

P=28yd

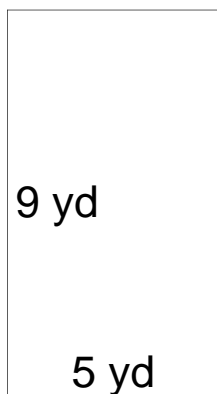

P=46yd

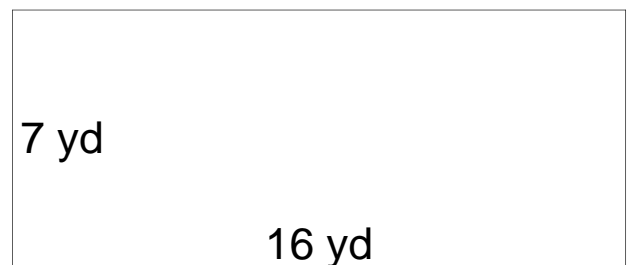

Name: _____

Date: _____

Perimeter: Rectangles and Triangles

Determine the perimeter of the following.

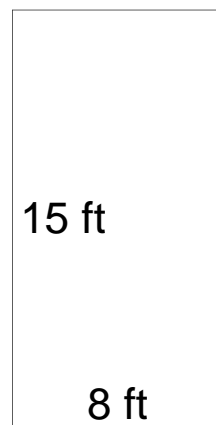
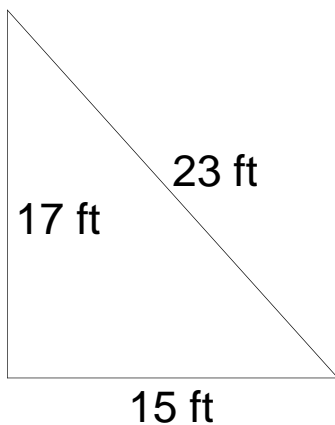
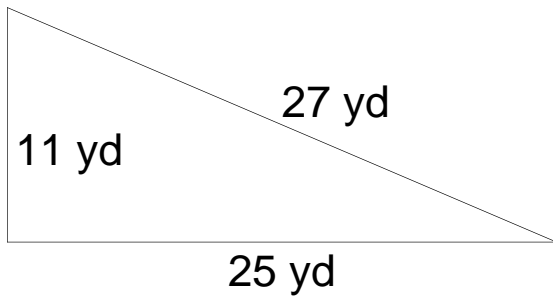
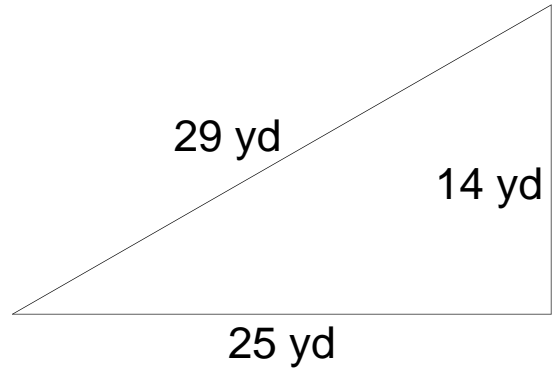
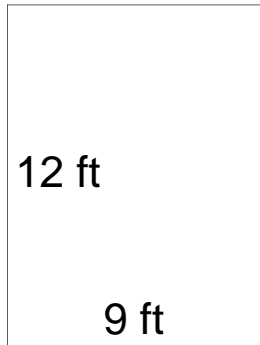

Name: _____

Date: _____



Perimeter: Rectangles and Triangles

Determine the perimeter of the following.

P=42ft

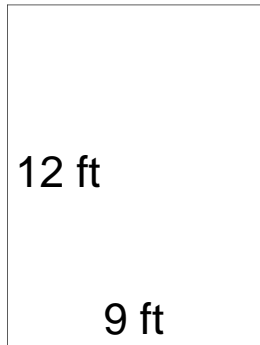

P=68yd

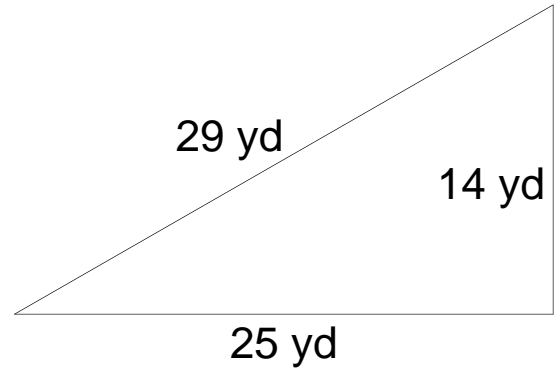

P=63yd

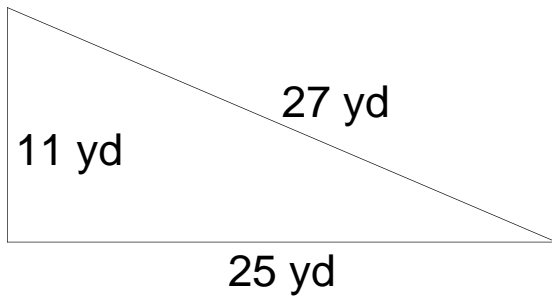

P=76ft

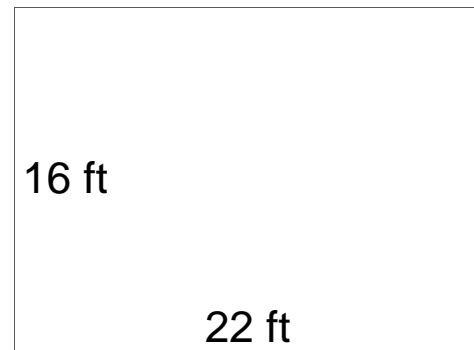

P=55ft

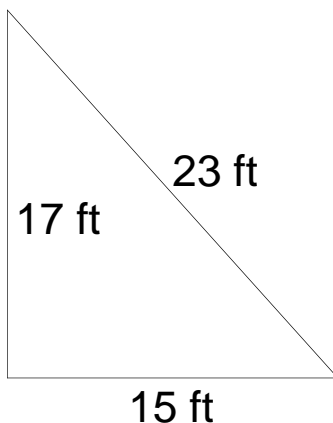

P=46ft

