

Name: _____

Date: _____

Area: Rectangles, Triangles, and L-Shapes

Determine the area of the following.

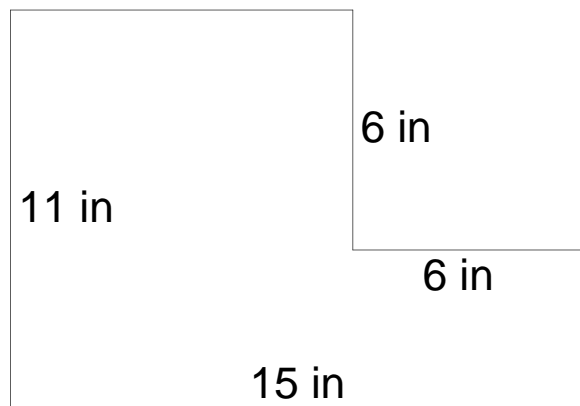
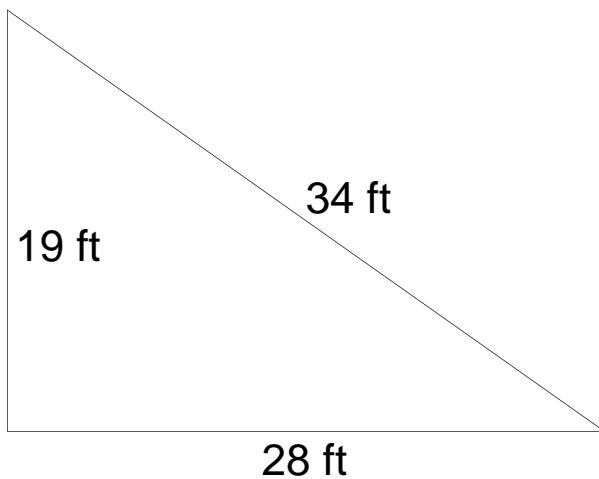
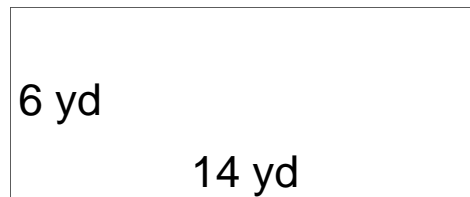
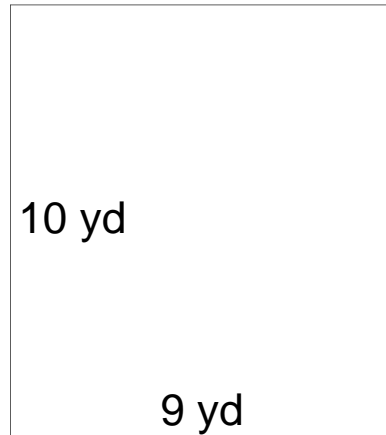
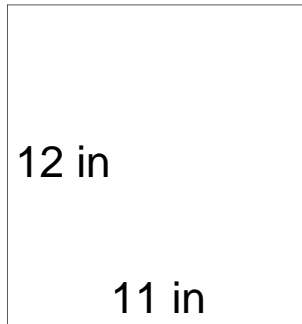

Name: _____

Date: _____



Area: Rectangles, Triangles, and L-Shapes

Determine the area of the following.

$A=132\text{in}^2$

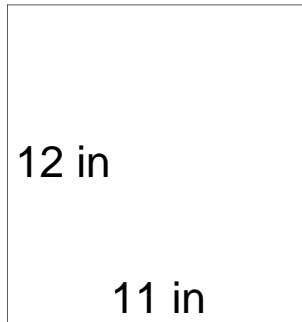

$A=90\text{yd}^2$

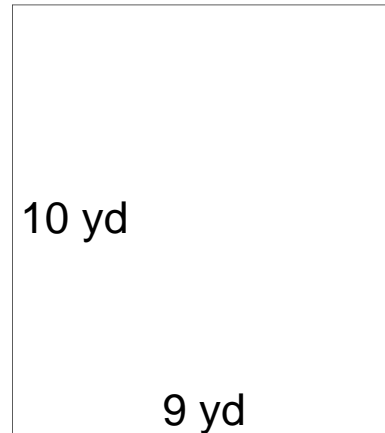

$A=476\text{yd}^2$

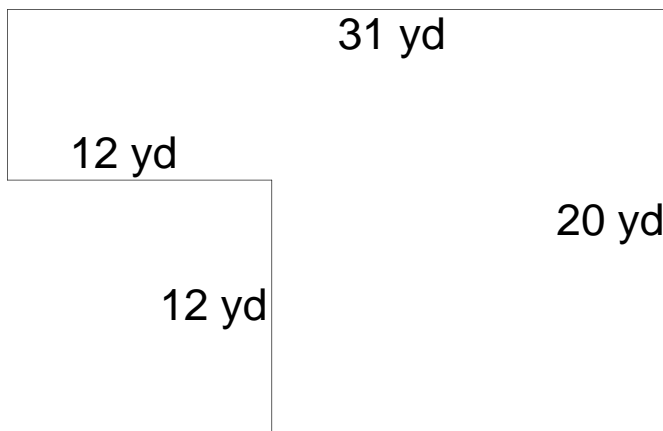

$A=84\text{yd}^2$

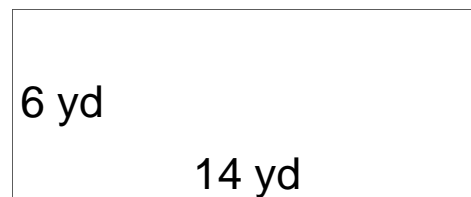

$A=266\text{ft}^2$

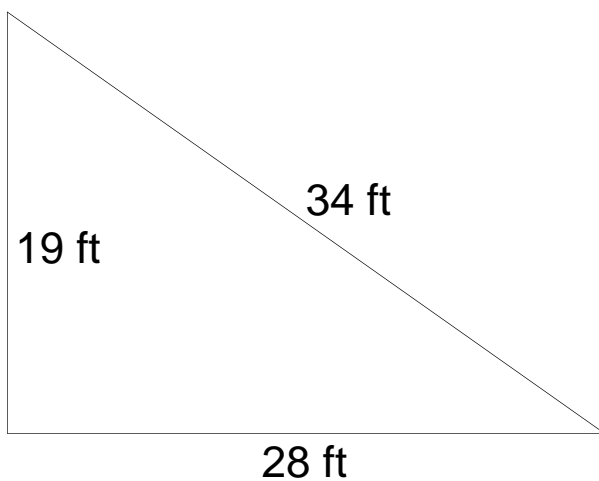

$A=129\text{in}^2$

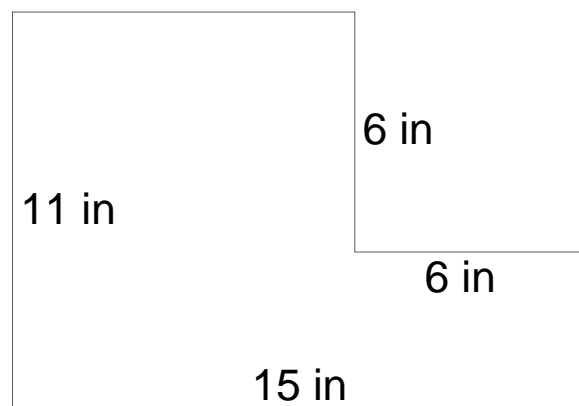

Name: _____

Date: _____

Area: Rectangles, Triangles, and L-Shapes

Determine the area of the following.

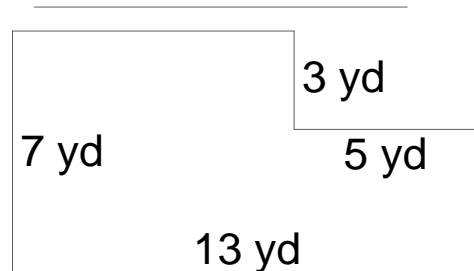
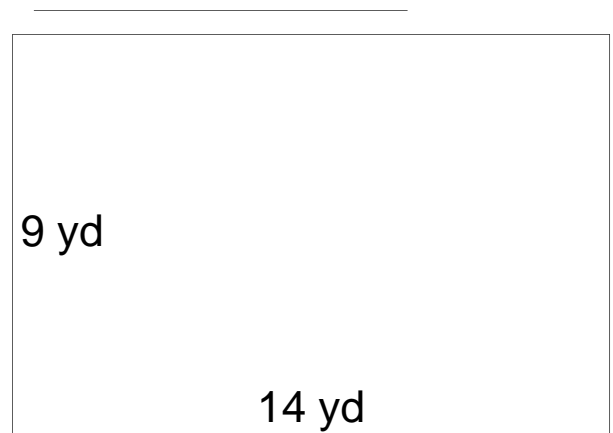
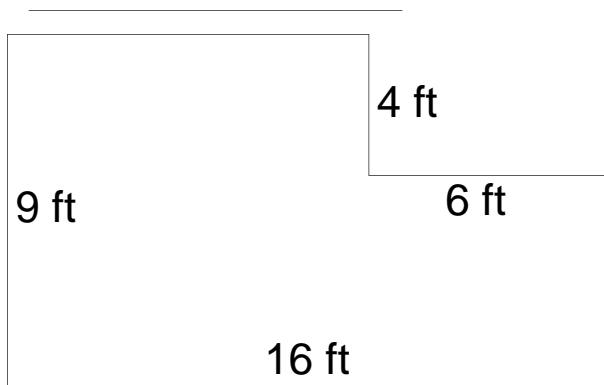
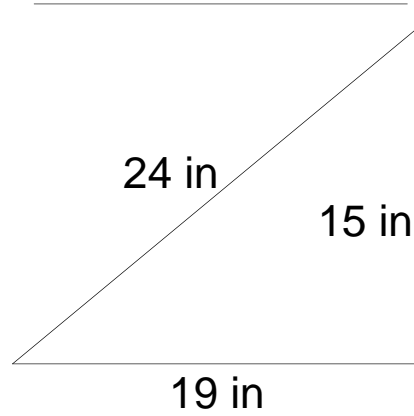
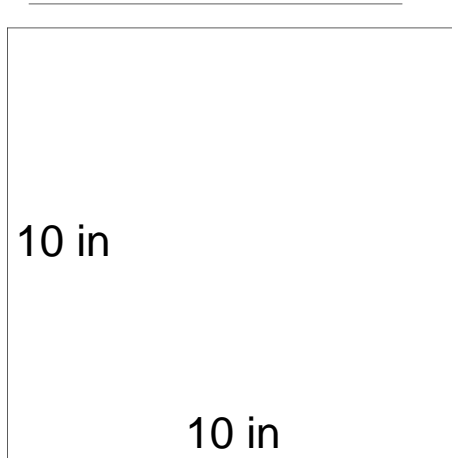

Name: _____

Date: _____



Area: Rectangles, Triangles, and L-Shapes

Determine the area of the following.

$A=100\text{in}^2$

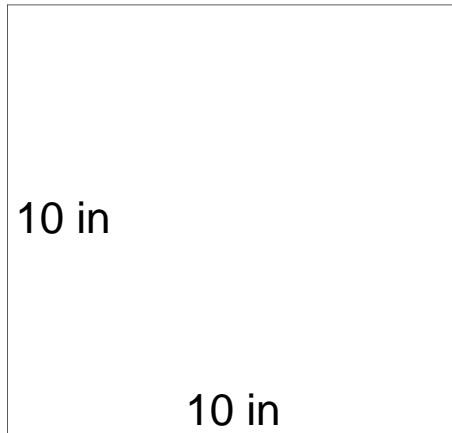

$A=143\text{in}^2$

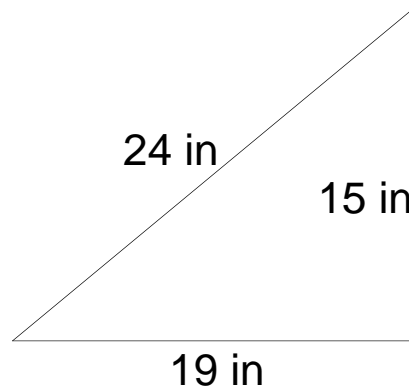

$A=120\text{ft}^2$

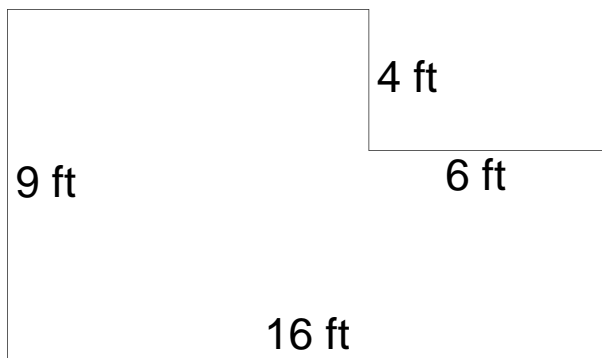

$A=126\text{yd}^2$

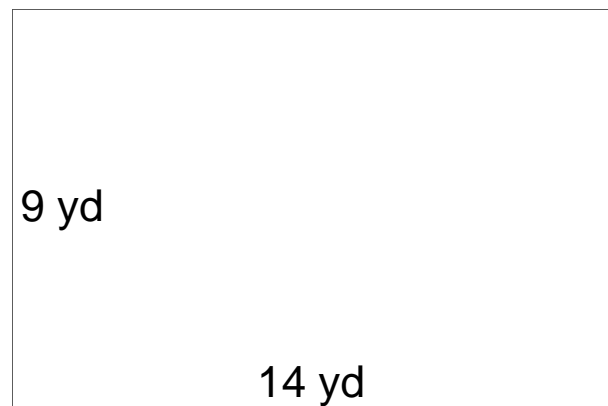

$A=126\text{in}^2$

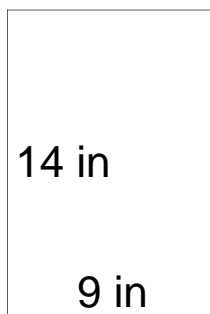

$A=76\text{yd}^2$

